

# 294/670 EM

## Dimensions

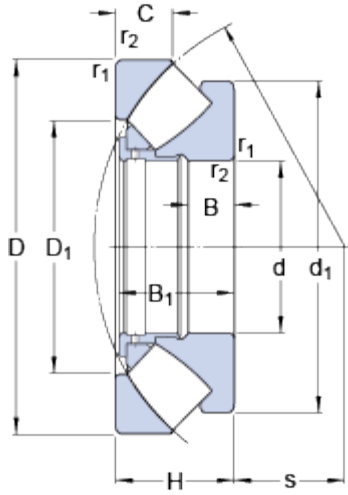

d	670	mm
D	1150	mm
H	290	mm
d <sub>1</sub>	≈ 1045	mm
D <sub>1</sub>	≈ 864	mm
B	110	mm
B <sub>1</sub>	280	mm
C	141	mm
s	387	mm
r <sub>1,2</sub>	min. 15	mm

## Abutment dimensions

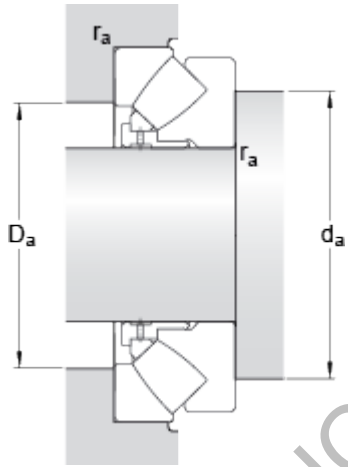

d <sub>a</sub>	min. 905	mm
D <sub>a</sub>	max. 1000	mm
r <sub>a</sub>	max. 12	mm

## Calculation data

Basic dynamic load rating	C	15400	kN
Basic static load rating	C <sub>0</sub>	68000	kN
Fatigue load limit	P <sub>u</sub>	4500	kN
Reference speed		240	r/min
Limiting speed		450	r/min
Minimum axial load factor	A	440	

## Mass

Mass bearing		1210	kg
--------------	--	------	----